

# TEMPORARY STRAINERS

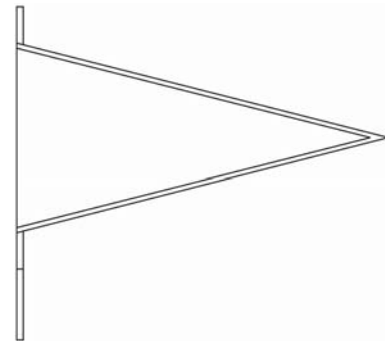

Model TB150NC



## FEATURES

- Standard in sizes 3/4" through 48". Larger sizes available. Consult factory
- Used primarily for new pipeline start-up or where solid loading is minimal
- 1/8" perforated screen with 22 gauge thickness is supplied as standard on sizes up to 8". 1/8" perforated screen with 16 gauge thickness is supplied as standard on sizes 10" to 24". Other meshes, perforations and materials are available upon request
- Available in conical, basket and plate configurations
- Available flat faced, raised face or RTJ with or without face serrations
- Available in carbon steel, 304 stainless steel or 316 stainless steel as standard. Other materials are available upon request
- Can be installed in horizontal or vertical pipelines with cone pointed upstream or downstream

## MATERIALS

PART	DESCRIPTION	
	Carbon Steel	304 Stainless Steel
Ring	A36	A240-304
Handle	A36	A240-304
Perforated Plate	A36	A240-304
Mesh (when used)	A276-304	A276-304

## STANDARD CONSTRUCTION DETAILS

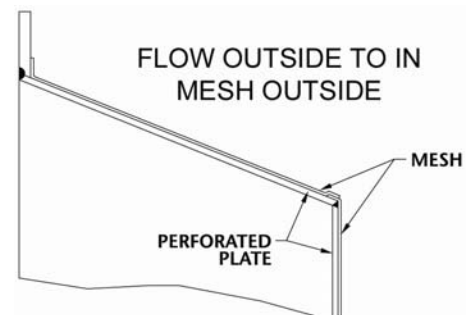
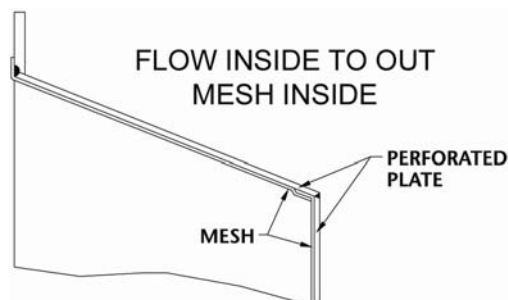
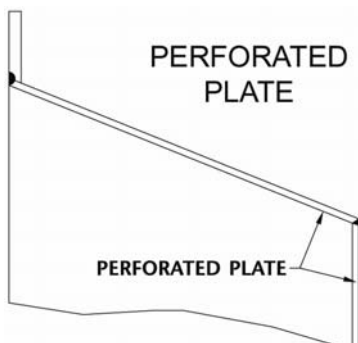

# TEMPORARY STRAINERS

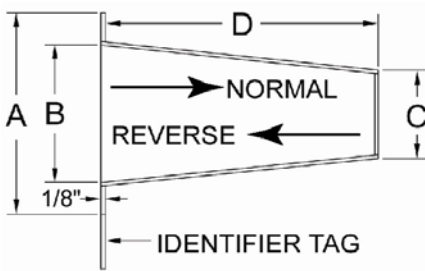

BASKET TYPE (TB)

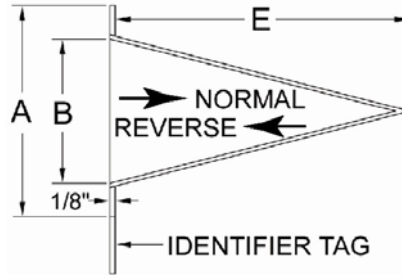

CONICAL TYPE (TC)

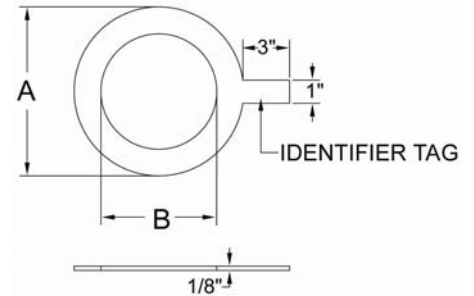

PLATE TYPE (TP)

## DIMENSIONS

Size		A (O.D.)				B (I.D.)		C		D (Basket Length)				E (Cone Length)			
		150/300#		600#						150%		200%		150%		200%	
mm	in	mm	in	mm	in	mm	in	mm	in	mm	in	mm	in	mm	in		
20	3/4	54	2-1/8	64	2-1/2	16	5/8	8	5/16	29	1-1/8	38	1-1/2	43	1-5/8	57	2-1/4
25	1	64	2-1/2	70	2-3/4	19	3/4	10	3/8	43	1-5/8	57	2-1/4	64	2-1/2	84	3-3/8
40	1-1/2	83	3-1/4	92	3-5/8	32	1-1/4	16	5/8	57	2-1/4	76	3	86	3-3/8	114	4-1/2
50	2	102	4	108	4-1/4	44	1-3/4	22	7/8	76	3	102	4	114	4-1/2	152	6
65	2-1/2	121	4-3/4	127	5	57	2-1/4	29	1-1/8	86	3-3/8	114	4-1/2	127	5	170	6-5/8
80	3	133	5-1/4	146	5-3/4	70	2-3/4	35	1-5/8	108	4-1/4	145	5-5/8	159	6-1/4	216	8-1/2
100	4	171	6-3/4	191	7-1/2	95	3-3/4	48	1-7/8	135	5-3/8	183	7-1/8	200	7-7/8	270	10-5/8
125	5	194	7-5/8	238	9-3/8	117	4-5/8	59	2-5/16	171	6-3/4	232	9-1/8	257	10-1/8	356	14
150	6	219	8-5/8	263	10-3/8	137	5-3/8	68	2-5/8	216	8-1/2	289	11-3/8	330	13	432	17
200	8	276	10-7/8	318	12-1/2	187	7-3/8	94	3-5/8	272	10-5/8	381	15	406	16	559	22
250	10	337	13-1/4	397	15-5/8	238	9-3/8	119	4-5/8	356	14	457	18	508	20	686	27
300	12	406	16	454	17-7/8	279	11	140	5-1/2	432	17	559	22	610	24	838	33
350	14	441	17-3/8	483	19	311	12-1/4	156	6-1/8	457	18	610	24	686	27	914	36
400	16	511	20-1/8	555	21-7/8	356	14	178	7	533	21	711	28	787	31	1041	41
450	18	540	21-1/4	603	23-3/4	400	15-3/4	200	7-7/8	610	24	813	32	889	35	1194	47
500	20	597	23-1/2	676	26-5/8	445	17-1/2	222	8-3/4	686	27	889	35	991	39	1346	53
600	24	708	27-7/8	784	30-7/8	540	21-1/4	270	10-5/8	813	32	1067	42	1194	47	1600	63

## ORDERING CODES

STRAINER TYPE	ANSI CLASS	FLOW TYPE	BODY MATERIAL	Open Area %	-	Screen Size
<b>Example:</b> TB	150	N	C	15	-	125
TB- Temporary Basket	150	N - Normal	C - Carbon Steel	10 - 100%		250 - 1/4" perf
TC - Temporary Conical	300	R - Reverse	S - 304 Stainless Steel	15 - 150%		125 - 1/8" perf
TP - Temporary Plate	600		S6 - 316 Stainless Steel	20 - 200%		062 - 1/16" perf
	900		SSL - 304L Stainless Steel	30 - 300%		047 - 3/64" perf
	1500		SS6L - 316L Stainless Steel			032 - 1/32" perf
	2500		(Others available upon request)			20M - 20 mesh
						40M - 40 mesh
						60M - 60 mesh
						80M - 80 mesh
						100M - 100 mesh

Colton has a policy of continuous product research and improvement and reserves the right to change design and specifications without notice



Tel: 1-888-300-9155 Fax: 1-888-300-9160 www.COLTONIND.com info@coltonind.com